

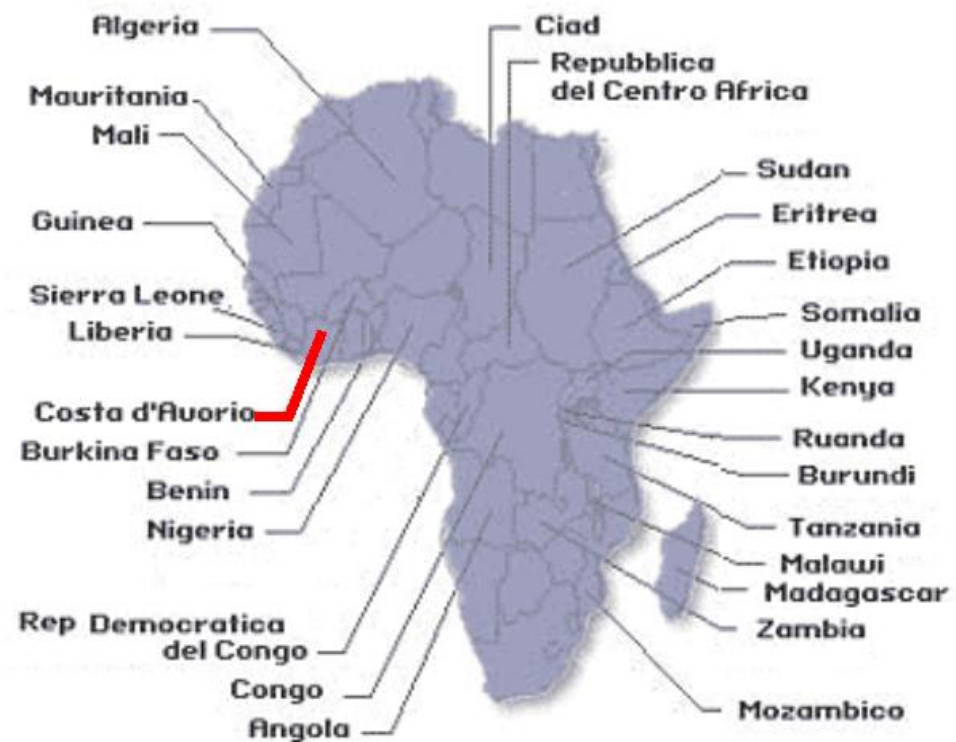

Sguazzi



 **UNA
BIBLIOTECA
per l'Ospedale di Man**

Perché nasce

Prima azione

Valutazione e studio

Progetto strutturato



Perché nasce

Prima azione

Valutazione e studio

Progetto strutturato

FEBBRAIO 2003



riapre l'ospedale di Man
saccheggiato e distrutto mesi prima
Ne assume la completa gestione

40 letti medicina

30 letti pediatria

30 letti chirurgia

10 letti ginecologia

250 bimbi Centro Nutrizionale

6 letti salle des urgences

2 sale operatorie

1 sala parto con 4 letti

IL PARADOSSO della CONDIVISIONE del digital divide attraverso utilizzo ICT

Personale sanitario di Man



Oratorio Jerzy Popieluszko
Curno





“Una biblioteca per l’ospedale di Man”

(Costa d’Avorio)

Dinamo Popieluszko Vecchie Glorie Curno

Atalanta Master over 35

“... salute è benessere, benessere è pace”

Curno, 1 giugno 2004



Sguazzi



Movimento dei Focolari



1 SETTEMBRE 2004

DIGITAL DIVIDE

Perché nasce

Prima azione

Valutazione e studio

Progetto strutturato



Disseminating health information in developing countries:
the role of the internet

Tessa Tan-Torres Edejer

Table 1 Estimated internet access worldwide, 2002

Region	Number of internet users (millions) ^a	Total population ^{1b}	Estimated internet access (%)
World	605.6	Over 6 billion	10
North America	182.7	316 million	58
Europe ^a	190.9	727 million	26
Latin America	33.3	520 million	7
Asia/Pacific region	187.2	3.7 billion	5
Africa	6.3	795 million	<1

^aIncluding the Commonwealth of Independent States.

80% SUDAFRICANI

1 : 6 = CHI ACCEDE : CHI NON ACCEDE in USA e Europa

1 : 5000 = CHI ACCEDE : CHI NON ACCEDE in Africa

Disseminating health information in developing countries: the role of the internet

Tessa Tan-Torres Edejer

BMJ 2000;321:797-800

The term digital divide often refers to unequal access to the internet in and between countries (table 1).^{5 8-10} But the divide also refers to inequities in ownership and use of technology, content, and telecommunications infrastructure.^{2 5 11}

Summary points

Information and communication technologies have not been harnessed systematically to improve the health of populations in developing countries

These technologies empower those who use information by providing them with a choice of information to be accessed in their own time and by allowing them to put their own information on the web

The current digital divide is more dramatic than any other inequity in health or income

The quality of health information available on the web is inconsistent, and the visibility of research from developing countries is limited

The way forward is to exploit the full interactivity of the internet, which allows rapid feedback and change to continuously mould information into useful knowledge

ICT: CONNESSIONI CON ATTIVITÀ STRATEGICHE DI COOPERAZIONE PIÙ AMPIE

Permettere l'accesso a informazioni affidabili al personale sanitario
pare essere l'intervento più appropriato in termini di rapporto costo/beneficio
per favorire un miglioramento sostenibile dei servizi sanitari

Pakenham-Walsh N, Priestly C, Smith R.

Meeting the information needs of health workers in developing countries. BMJ 1997;314:90

ONU 2000: Millenium Action Plan

Miglioramento della salute attraverso lo sviluppo dell'ICT

Millennium report of the secretary-general of the United Nations. 2000.

www.un.org/millennium/sg/report - accessed 28 Apr 2004).

OMS 2002: HINARI

Health Inter Network to Access Research Initiative

*SVI Katikireddi **HINARI: bridging the global information divide** BMJ 2004;328;1190-1193*

ONU 2004 Food and Agriculture Organization: AGORA

Access to Global Online Research in Agriculture

AGORA - www.aginternetwork.org

ESA 2007: Capacity building through ICT

<http://www.actnowalliance.org/>

Information and communication technologies (ICT) are often promoted as bridges to better governance, economies, and health,¹⁻³ but examples of how these bridges can be successfully built are rare.² In this

- 1 www.dotforce.org (Digital Opportunities Task Force).
- 2 Wade RH. Bridging the digital divide: new route to development or dependency. *Global Governance* 2002;8:448-66.
- 3 International Telecommunication Union. *World telecommunications development report*. Geneva: ITU, 2002.
- 4 United Nations. *We the peoples: the role of the United Nations in the 21st century*. Millennium report of the secretary-general of the United Nations, 2000. www.un.org/millennium/sg/report (accessed 28 Apr 2004)
- 5 Health InterNetwork. *The Health InterNetwork India Pilot Project*, 2003. (www.hin.org.in)



The Ptolemy project: a scalable model for delivering health information in Africa

Massey Beveridge, Andrew Howard, Kirsteen Burton and Warren Holder

BMJ 2003;327:790-793

doi:10.1136/bmj.327.7418.790

Summary points

Ptolemy is a new model for electronic access to medical literature for doctors in developing countries

Surgeons in east Africa become research affiliates of the University of Toronto and have access to the full-text resources of the university library via a secure internet system that monitors and verifies use

By engaging a well defined group of end users in an electronic research community, Ptolemy contributes directly to building research capacity in Africa

Ptolemy is a small project but it has potential for being widely and economically reproduced

BMJ

Digital bridges need concrete foundations: lessons from the Health InterNetwork India

Shyama Kuruvilla, Joan Dzenowagis, Andrew Pleasant, Ranjan Dwivedi,
Nirmala Murthy, Reuben Samuel and Michael Scholtz

BMJ 2004;328:1193-1196
doi:10.1136/bmj.328.7449.1193

The Health InterNetwork initiative focuses on four main components: connectivity (facilitating information access and use through ICT); content (providing timely, relevant, and high quality information); capacity building (developing skills in ICT management and use); and policy (lowering the barriers to ICT integration into public health practice).

Summary points

The World Health Organization's Health InterNetwork India pilot project implemented and analysed processes for establishing and using information and communication technologies (ICT) in India's health system

The project shows that national and international partnerships can help to do this effectively when connectivity, content, capacity building, and policy components are included

Computers and internet connectivity can be provided and meet real needs, even in remote settings

Identifying and supporting champions is vital for the successful adoption of ICT

Careful assessment and the involvement of local partners can help achieve a balance between short term incentives to adopt ICT and the long term goal of using ICT to strengthen public health practice



Perché nasce

Prima azione

Valutazione e studio

Progetto strutturato

OBIETTIVO GENERALE

Promozione e valorizzazione delle scienze

mediche e sociali

della regione delle Diciotto Montagne

OBIETTIVI SPECIFICI

AMPLIARE LE COMPETENZE

DEL PERSONALE SANITARIO LOCALE

GARANTIRE LA SOSTENIBILITA'

DELLE ATTIVITA' DEL COMITATO BIBLIOTECA

AZIONI

AMPLIARE LE COMPETENZE DEL PERSONALE SANITARIO LOCALE

**Incremento del patrimonio
e servizi della Biblioteca del CHR**

**Adeguamento tecnologico della
Biblioteca**

Interventi di formazione a distanza

DESTINATARI diretti

**Figure medico-sanitarie del
CHR di Man e dispensario
dei Focolari:**

- 27 infermieri**
- 14 tecnici specializzati**
- 14 medici**
- 61 altre professionalità**

AZIONI

GARANTIRE SOSTENIBILITA'

ATTIVITA' COMITATO BIBLIOTECA

- **Sviluppo delle competenze gestionali del Comitato Biblioteca**
- **Gestione attività di marketing e autofinanziamento**
- **Promozione di una rete locale per l'alta formazione continua nel sistema sanitario**

DESTINATARI diretti

15 membri Comitato Biblioteca

Informatici e Amministratori

Sistema scolastico, Capovillaggi

Intera comunità regionale

**Strutture del sistema sanitario ivoriano
e loro dipendenti**

OBIETTIVO A LUNGO TERMINE

Miglioramento della salute dei cittadini di Man

DESTINATARI indiretti

EFFETTI COLLATERALI

- PENSARE AL FUTURO
- DIVENIRE UN POLO DI ATTRAZIONE CULTURALE

DESTINATARI indiretti

PARTNERSHIP



DIVULGAZIONE



UNA BIBLIOTECA PER L'OSPEDALE DI MAN

- **Con libri - MSF, CICR, Elsevier -**
- **Possibilità di accesso alla tecnologia delle informazioni e telecomunicazioni (ICT)**

- la connettività: per permettere il facile accesso e l'uso delle informazioni attraverso l'ICT
- i contenuti: per assicurare aggiornamento, approfondimenti rilevanti e di qualità

- l'interattività per diventare protagonisti nella produzione di informazioni

- lo sviluppo della capacità di usare e gestire l'ICT in modo appropriato
- favorire l'inserimento e l'utilizzo dell'ICT nel sistema sanitario



- la connettività:
ACT NOW
AETHRA
Centro Focolari
4M ITALIA
Fraternità Cappuccini

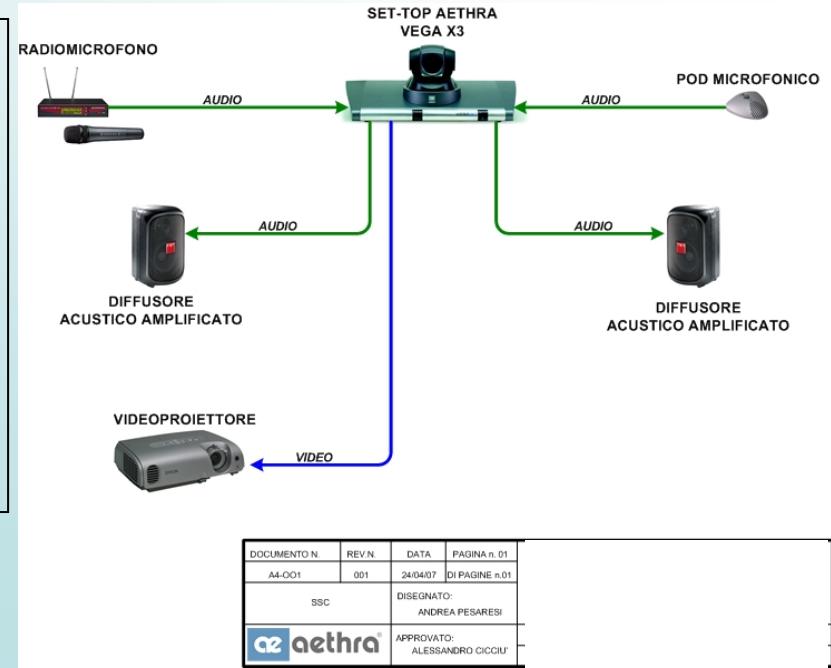

- i contenuti

IMPARARE A CERCARE

Sbbl

Centro Farmacologico Negri

CONSULENZA CLINICA

Ospedali Riuniti

Cliniche Gavazzeni

International Heart School

Bicocca



Satellite station

M. Victoria - Chateau

Man Hospital

WiFi station



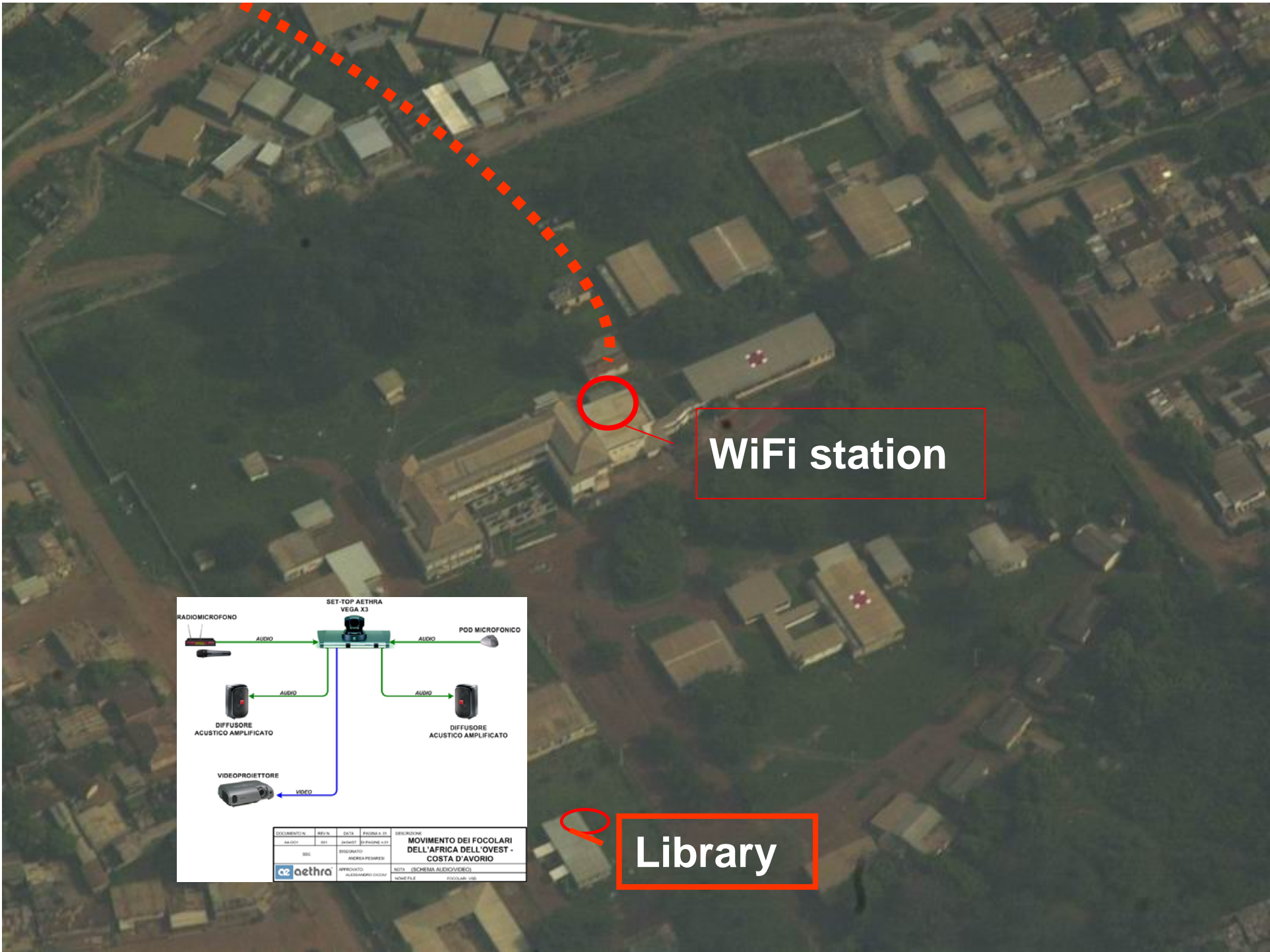

WiFi station

Library

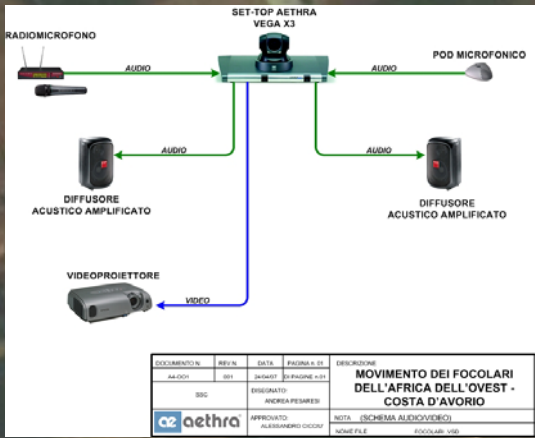

- lo sviluppo della capacità di usare e gestire l'ICT in modo appropriato

COMITATO

INFORMATICI LOCALI

ACT NOW

METID POLITECNICO

- favorire l'inserimento e l'utilizzo dell'ICT nel sistema sanitario

CHR (Centro Ospedaliero Regionale) di Man.

**Consiglio Generale di Man, Commission Santé, Environnement
et Affaire sociaux**

Caritas, Man DAPH

.....

**Unità di Ematologia e Trombosi
Dipartimento di Medicina
Azienda Ospedaliera San Paolo**

**Webm-org
(Work groups for
Evidence Based Medicine)**

- **l'interattività per diventare protagonisti nella produzione di informazioni**

COMITATO BIBLIOTECA

**Consiglio Generale di Man, Commission Santé, Environnement
et Affaire sociaux. Costa d'Avorio**

CHR (Centro Ospedaliero Regionale) di Man

FOCOLARI

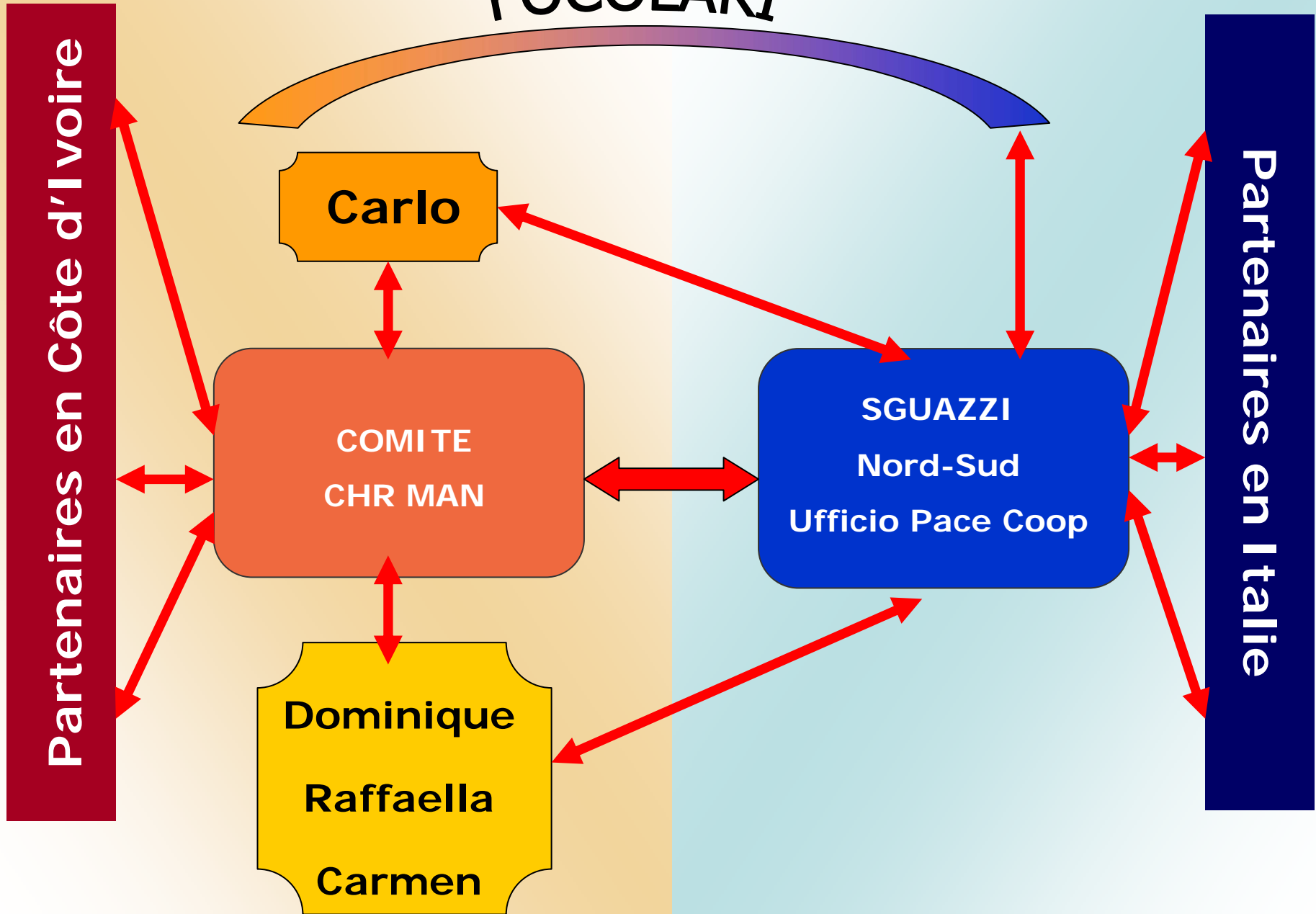

CONNETTIVITA'	30000 eu
ENCICLOPEDIA MEDICHE	20000 eu
RISTRUTTURAZIONE	5000 eu
FUNZIONAMENTO	15000 eu
VALORIZZAZIONI	30000 eu

XMAS PROJECT

NORD-SUD

SGUAZZI

AETHRA

ELSEVIER

Tino Sana Arredamenti

Consulenze Ambientali

Oratorio Curno

PARTNERSHIP



DIVULGAZIONE



- **Instabilità Costa d'Avorio**
- **Assenza grande partner**
- **Tempi lunghi**

Tenuta Sguazzi \ Nord-Sud

Mantenere insieme e calda la rete

Tenuta Comitato locale ivoriano

- **Reperimento fondi privati\Attesa risultati bandi**

Comitato

. Relazioni

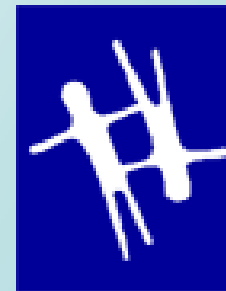

PROGETTO DI VALORIZZAZIONE PERSONE:

- Assunzione di Responsabilità
- Assunzione di Cittadinanza

Fiducia

Per migliorare l'impatto e la comprensione del progetto è stata pensata una speciale azione di divulgazione che dovrà saper miscelare il linguaggio scientifico e artistico.

Narrative medicine

A Model for Empathy, Reflection, Profession and Trust

Jama 2001;286:1897-1902



In collaborazione con Comitato biblioteca

presenta



Compagnia Brincadera



Alfa première

è un momento teatrale al servizio di un progetto.

- Biblioteche
- Associazioni
- Scuole
- Università
- Oratori
- Spazi informali

- *TEATRI*